

2PBM 12

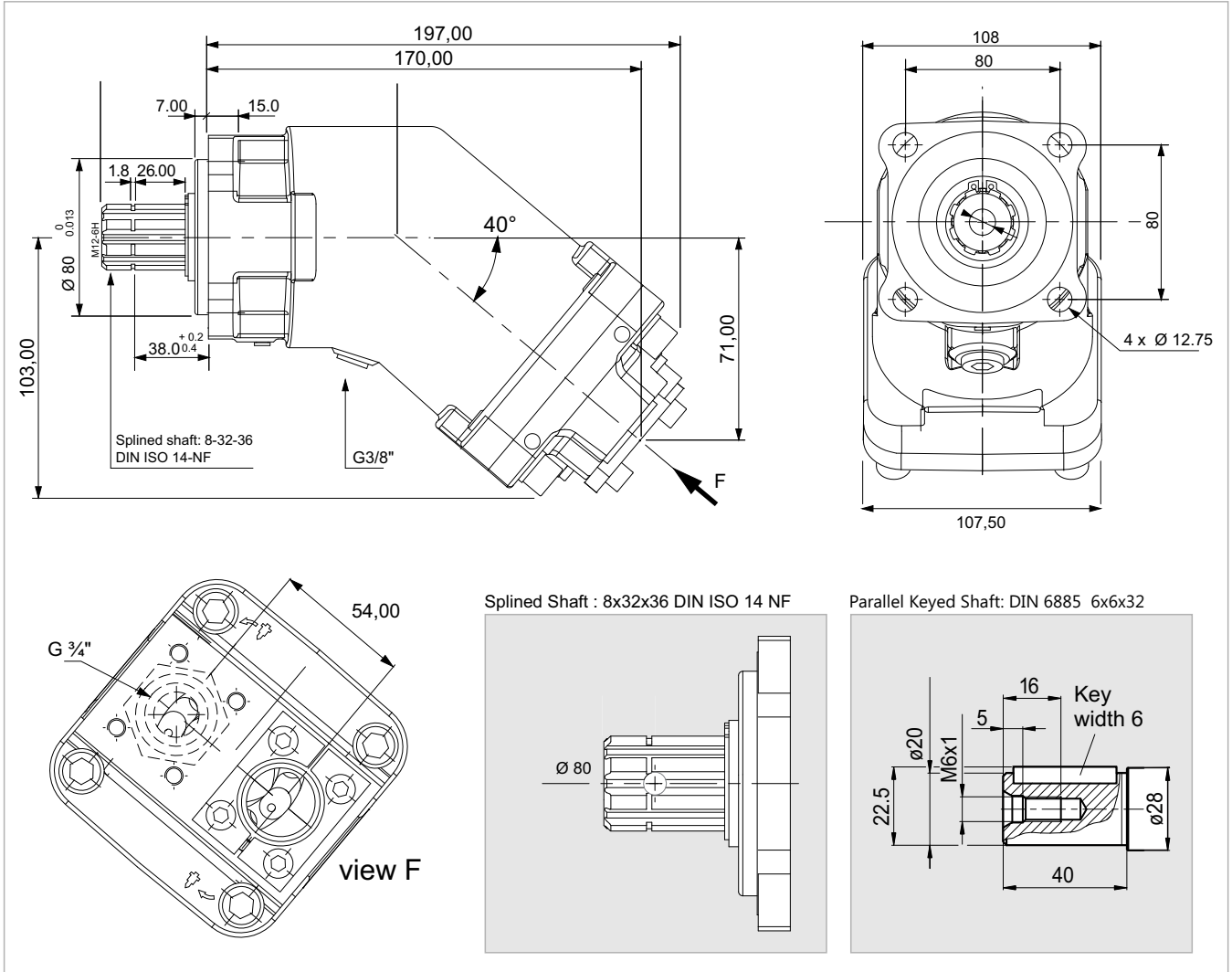

x 1000 rpm	12,00 cc
x 1500 rpm	18,00 cc
Max. Continuous Pump Speed	8000 rpm
Max. Intermittent Pump Speed	8800 rpm
Max. Continuous Pressure	400 bar
Max. Peak Pressure	450 bar
Torque bar	0.18 m.N/bar
Torque at 350 bar	66 m.N
Weight without accessories	9,00 kg
Weight with accessories	9,50 kg
Max. Motor Temperature	-25°
Min. Motor Temperature	110°