

2PS 108

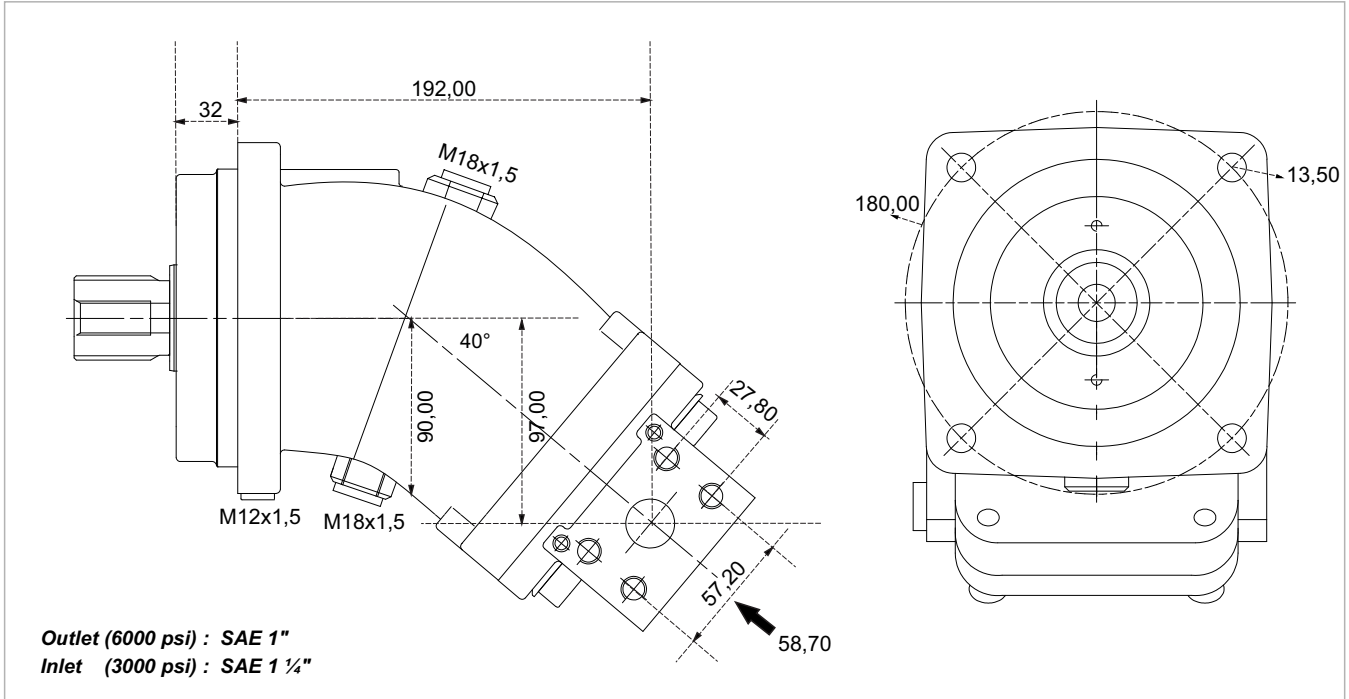

x 1000 rpm	108,40 cc
x 1500 rpm	162,60 cc
Max. Continuous Pump Speed	2000 rpm
Max. Continuous Pressure	400 bar
Max. Peak Pressure	450 bar
Max. Torque at 350 bar	600 Nm
Max. Flow	216,00 l/min.
Min. Pump Temperature	-25 °C
Max. Pump Temperature	110 °C
Weight without accessories	22,50 kg
Weight with accessories	23,00 kg
Rotation	CW-CCW

